

ASSEMBLY INSTRUCTION

MODEL : HM 338.02 DESC : WARDROBE WITH 2 DOORS & DRAWER

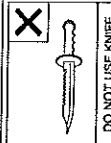

DO NOT USE KNIFE

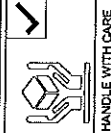

HEAT

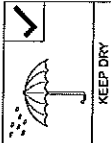

CHEMICAL

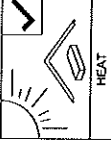

KEEP DRY

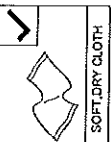

SOFT DRY CLOTH

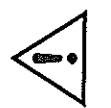

HANDLE WITH CARE

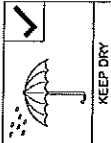

DO NOT USE KNIFE

HARDWARE		PART LIST	
A	WOOD SCREW 6 X 3/8	18	
B	12MM CD SCREW M3.5X12MM	26	
C	50MM CD SCREW MAX35MM	4	
D	38MM CD SCREW MAX30MM	30	
E	NAIL 5/8	50	
F	12MM TAPPING SCREW M3X12MM	24	
G	HANDLE 108 18MM (PVC)	4	
H	25MM CD SCREW MAX35MM	4	
I	PVC NAIL WITH PN 1/2	5	
J	2 PIN STOPPER	1	
K	HINGES 208	6	
L	DRAWER SLIDE 1/4" (CLOR)	2	
M	DRAWER SLIDE 1/4" (CLOR)	2	
N	18MM CHROME PIPE	1	
O	L BRACKET M302	1	

STEP 1

STEP 2

STEP 3

STEP 4

STEP 5

STEP 6

STEP 7

STEP 8

STEP 9

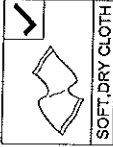

SOFT, DRY CLOTH

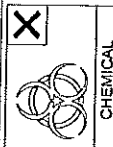

CHEMICAL

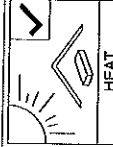

HEAT

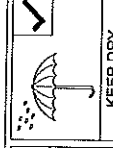

KEEP DRY

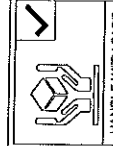

HANDLE WITH CARE

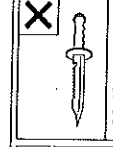

DO NOT USE KNIFE

ASSEMBLY INSTRUCTION

MODEL : HM 338.02

DESC : WARDROBE WITH 2 DOORS & DRAWER

STEP 10

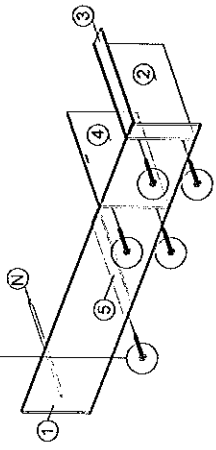
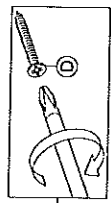

STEP 11

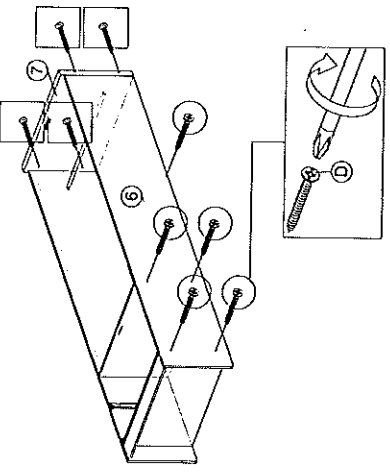
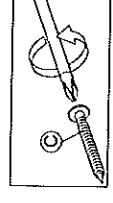

STEP 12

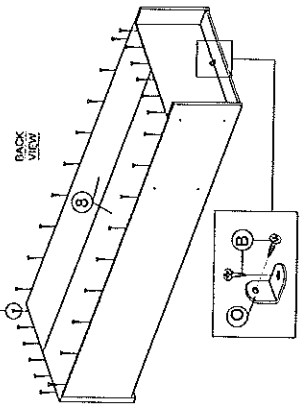
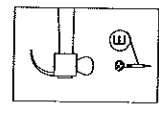

COMPLETED

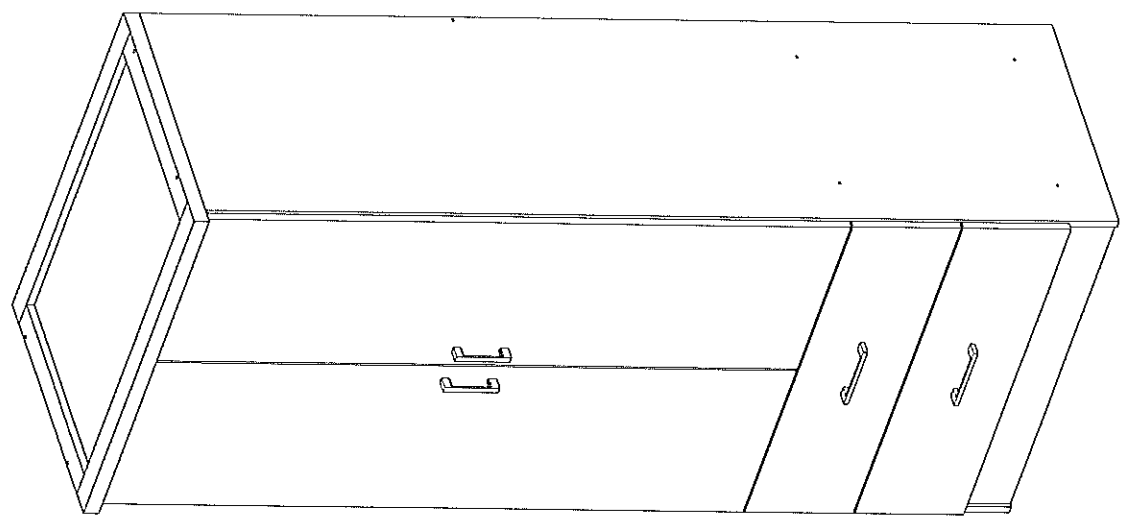

STEP 13

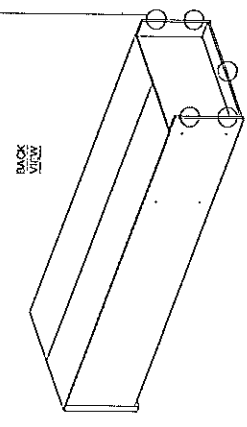
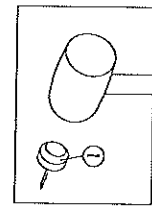

STEP 14

